

Features

- Diffused Junction
- Low Forward Voltage Drop
- High Current Capability
- High Reliability
- High Surge Current Capability

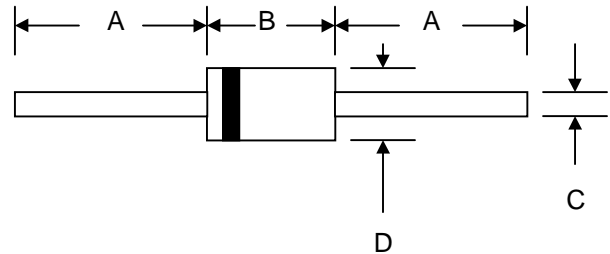

Mechanical Data

- Case: DO-201AD, Molded Plastic
- Terminals: Plated Leads Solderable per MIL-STD-202, Method 208
- Polarity: Cathode Band
- Weight: 1.2 grams (approx.)
- Mounting Position: Any
- Marking: Type Number
- **Lead Free: For RoHS / Lead Free Version**

DO-201AD		
Dim	Min	Max
A	24.5	—
B	7.20	9.50
C	1.10	1.30
D	5.00	5.60
All Dimensions in mm		

Maximum Ratings and Electrical Characteristics @ $T_A=25^\circ\text{C}$ unless otherwise specified

Single Phase, half wave, 60Hz, resistive or inductive load.
For capacitive load, derate current by 20%.

Characteristic	Symbol	MUR 405	MUR 410	MUR 415	MUR 420	MUR 440	MUR 460	MUR 480	MUR 4100	Unit
Peak Repetitive Reverse Voltage	V_{RRM}	50	100	150	200	400	600	800	1000	V
Working Peak Reverse Voltage	V_{RWM}									
DC Blocking Voltage	V_R									
RMS Reverse Voltage	$V_{R(RMS)}$	35	70	140	210	280	420	560	700	V
Average Rectified Output Current (Note 1)	I_O	4.0								A
Non-Repetitive Peak Forward Surge Current 8.3ms Single half sine-wave superimposed on rated load (JEDEC Method)	I_{FSM}	150								A
Forward Voltage @ $I_F = 4.0A$	V_{FM}	1.0			1.3		1.7			V
Peak Reverse Current @ $T_A = 25^\circ\text{C}$ At Rated DC Blocking Voltage @ $T_A = 100^\circ\text{C}$	I_{RM}					2.0				μA
						100				
Reverse Recovery Time (Note 2)	t_{rr}	50						75		nS
Typical Junction Capacitance (Note 3)	C_j	80						50		pF
Operating Temperature Range	T_j	-55 to +150								$^\circ\text{C}$
Storage Temperature Range	T_{STG}	-55 to +150								$^\circ\text{C}$

Note: 1. Leads maintained at ambient temperature at a distance of 9.5mm from the case
2. Measured with $I_F = 0.5A$, $I_R = 1.0A$, $IRR = 0.25A$. See figure 5.
3. Measured at 1.0 MHz and applied reverse voltage of 4.0V D.C.

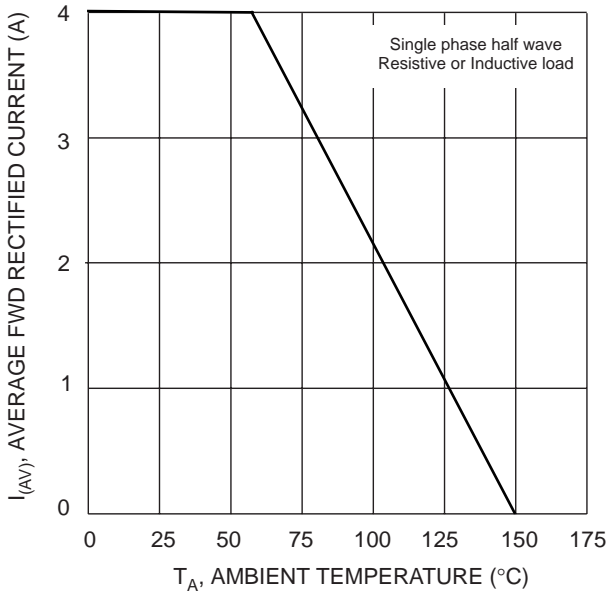

Fig. 1 Forward Current Derating Curve

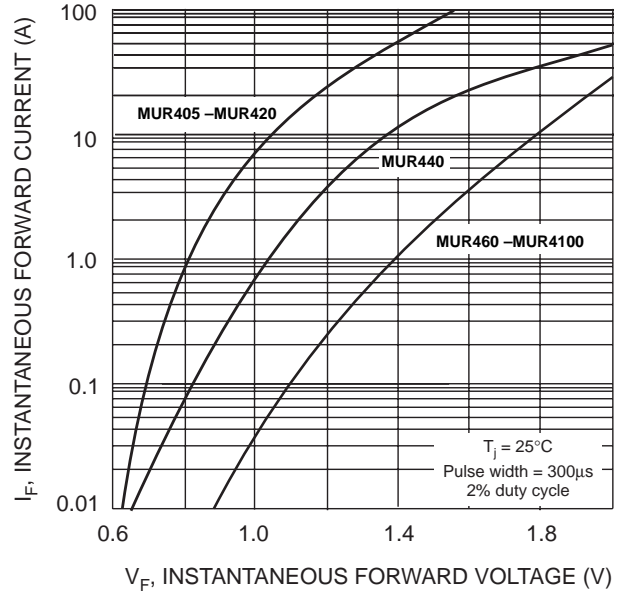

Fig. 2 Typical Forward Characteristics

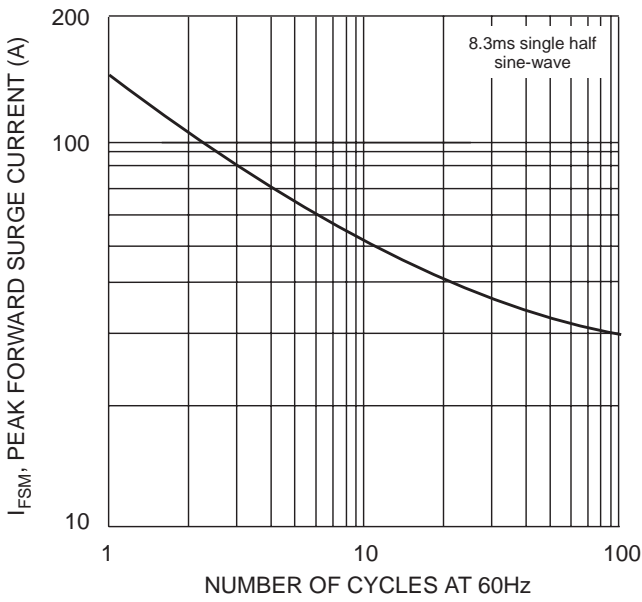

Fig. 3 Peak Forward Surge Current

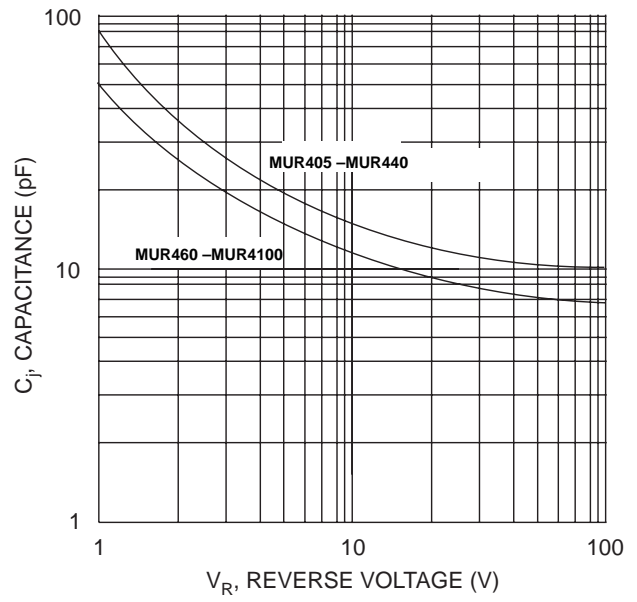
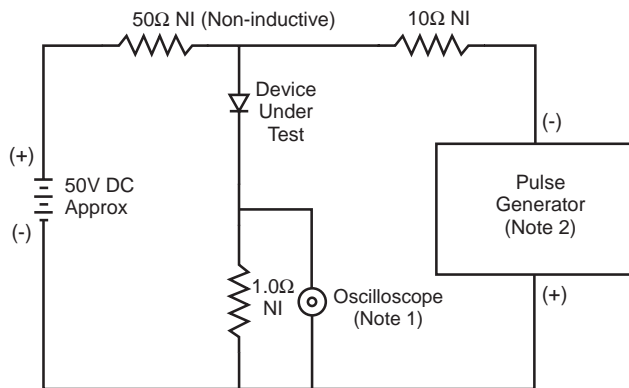

Fig. 4 Typical Junction Capacitance



- Notes:
1. Rise Time = 7.0ns max. Input Impedance = 1.0MΩ, 22pF.
 2. Rise Time = 10ns max. Input Impedance = 50Ω.

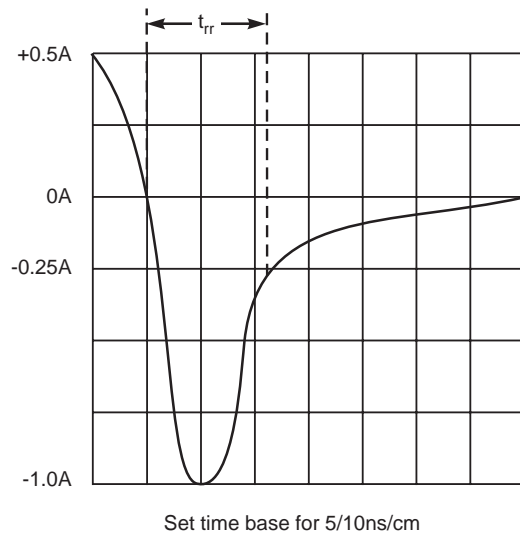

Fig. 5 Reverse Recovery Time Characteristic and Test Circuit